

We reserve all rights in this document and in the information contained herein. Reproduction, use or disclosure to third parties without express authority is strictly forbidden.

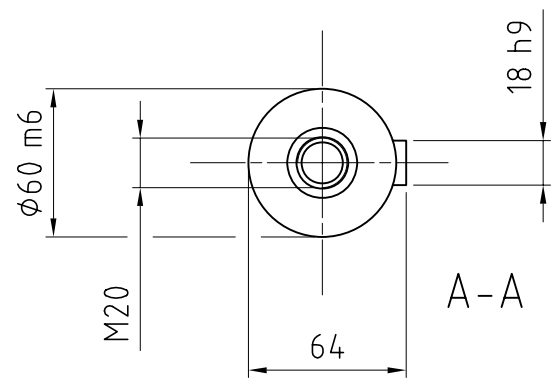
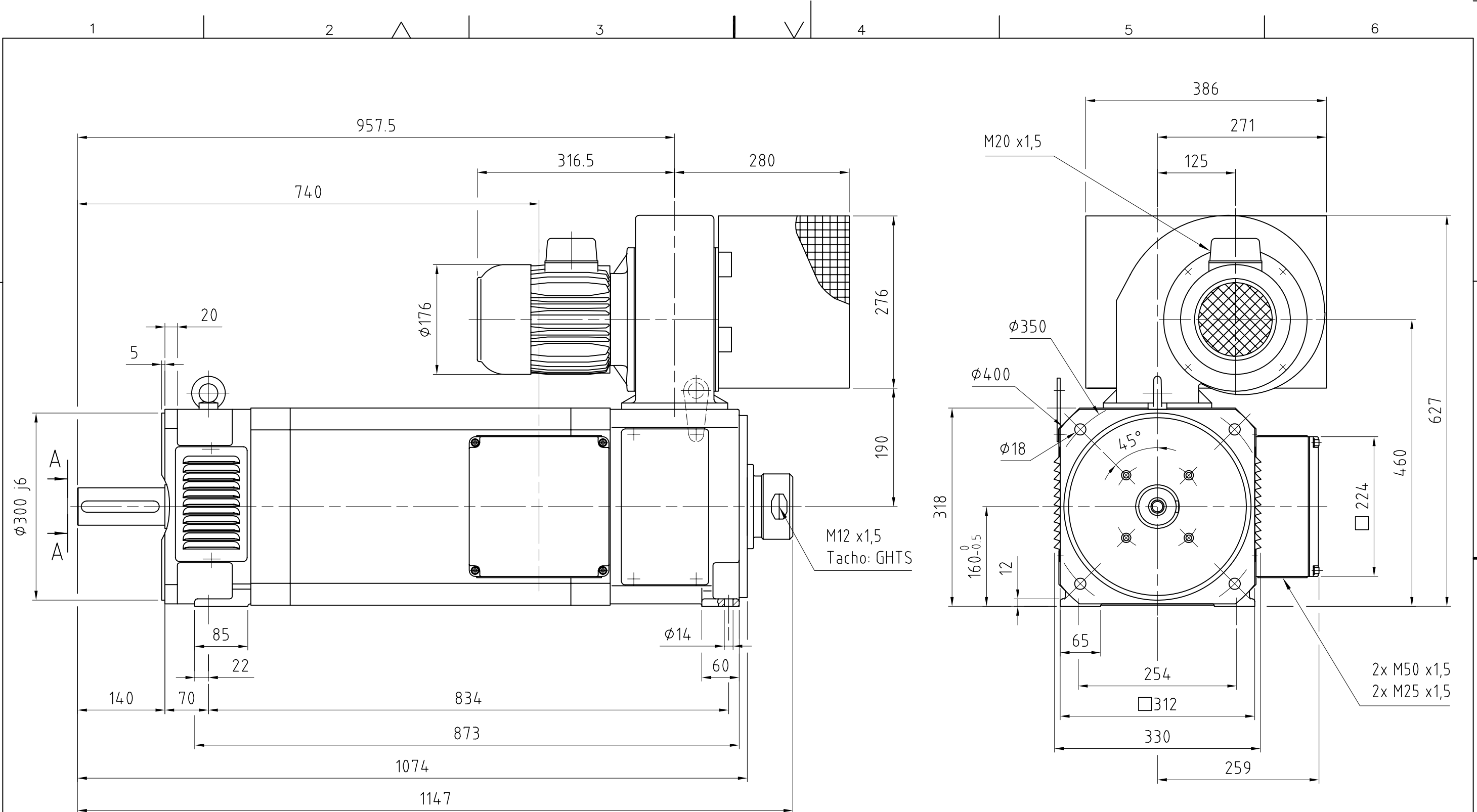

IM 2001  
IP 23  
IC 06

Based on	Pcl 808430	Reg no 3HB	
Prepared	07-01-11	H Hällstrand	Dimension Print DMR 160LN
Approved	07-01-12	RUNE GUNNARSSON	Måttskiss DMR 160LN
Resp dept AP/MGT		Take over dept	Revision
			Lang 82
			Page 1
			Cont
3BSM 016975-2			