

We reserve all rights in this document and in the information contained herein. Reproduction, use or disclosure to third parties without express authority is strictly forbidden.

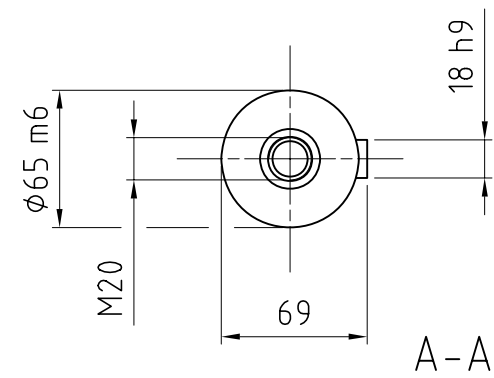
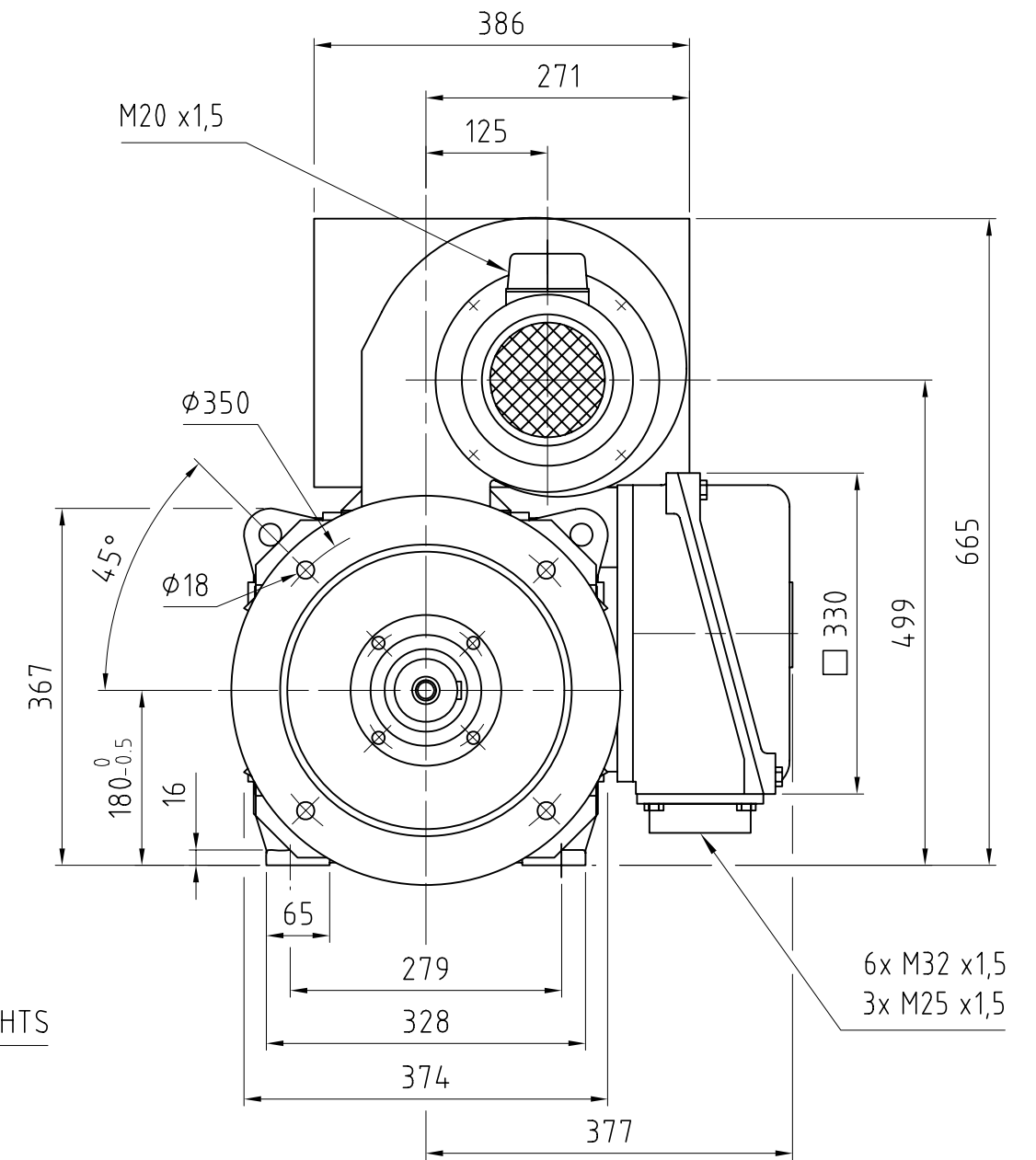
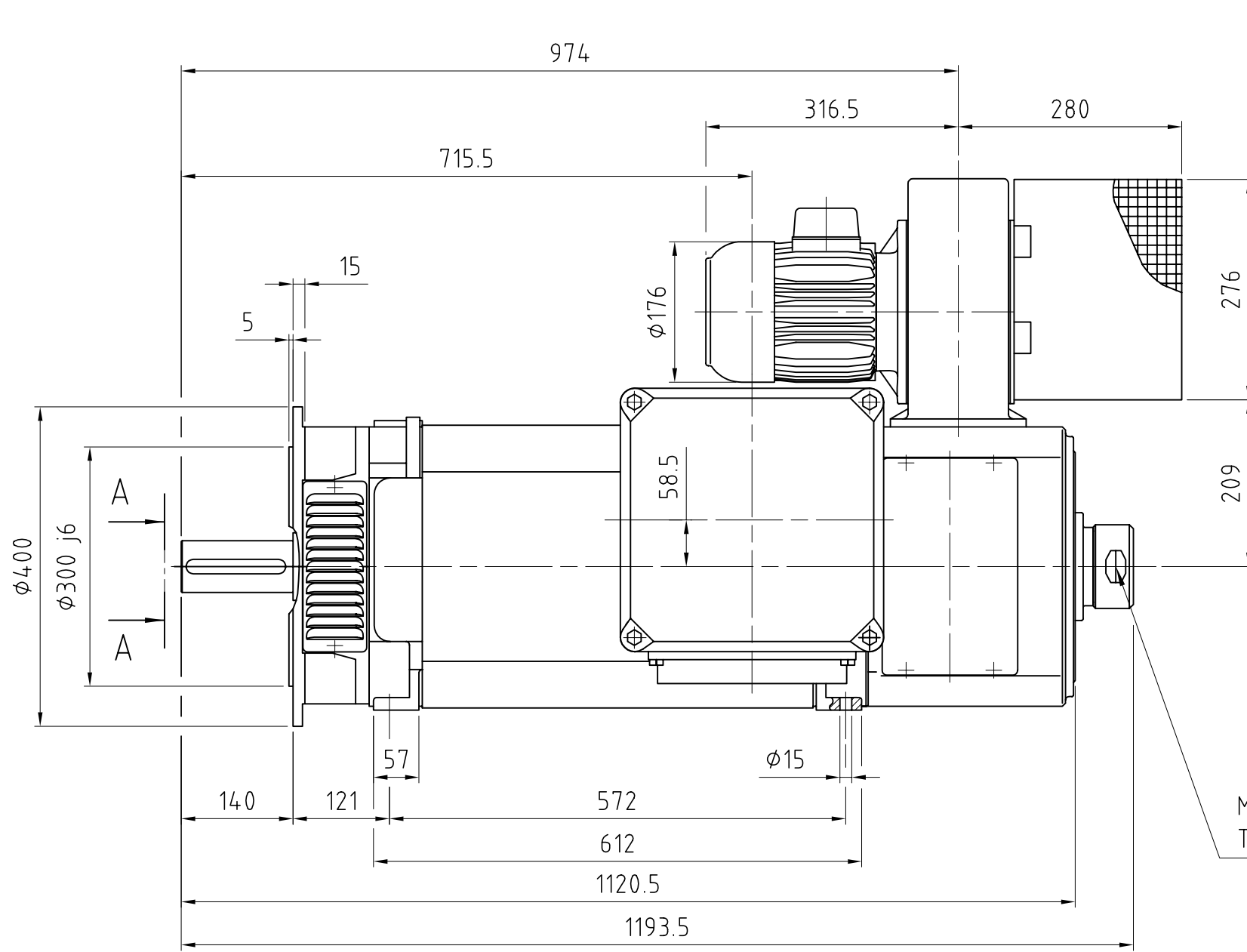

IM 2001
IP 23
IC 06

Based on	Pcl 808430	Reg no 3HB	
Prepared	07-01-05	H Hällstrand	Dimension Print DMR 180LN
Approved	07-01-12	RUNE GUNNARSSON	Måttskiss DMR 180LN
Resp dept AP/MGT	Take over dept	Revision 1	Lang 82
			Page 1
			Cont
3BSM 016955-2			